

Facsimile

Quick Reference Guide

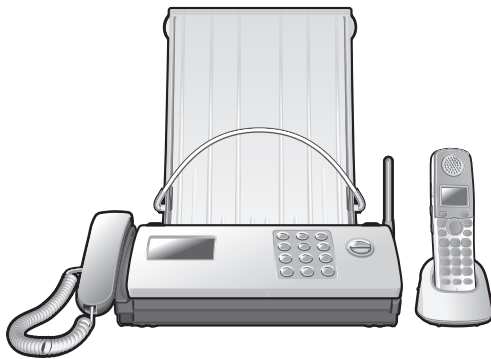

KX-PW603DL

Model No. **KX-PW603DL**
KX-PW603DW

Main unit: KX-PW603
 Portable handset: KX-FKN511

Thank you for purchasing a Panasonic facsimile.

Table of Contents

Finding the controls	2
Installations and connections	4
Setting the date and time	7
Setting your facsimile telephone number	7
Setting your logo	8
Character input and command key table	9
Automatic dialing on the main unit	10
Automatic dialing on the portable handset (KX-FKN511).....	11
Intercom	12
Sending faxes.....	13
Receiving faxes	14
Operating the built-in answering device	15
Specifications	18

- This guide explains some basic features and operations, but not all of them. For further details, see the Japanese operating instructions.
- This product is designed for use in Japan. Panasonic cannot provide service for this product if used outside Japan.
- Any details given in this guide are subject to change without notice.

This unit is equipped with the voice guide features. (Japanese only)

■ Operation guide

This unit starts to instruct you of the operation, when you open the control panel cover or insert the document into the document feeder.

● To cancel the operation guide



■ Reading-out dial

This unit announces the number dialed, when you call with the main unit.

● To cancel the reading-out dial

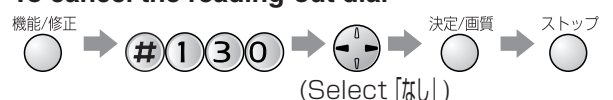

Finding the controls

Main unit

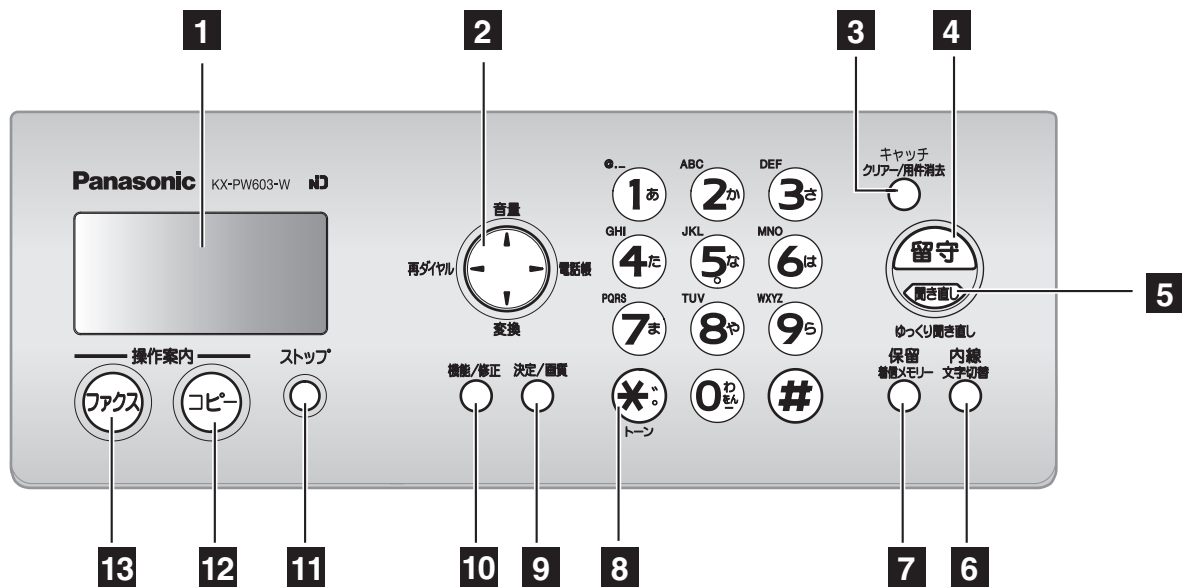

1 Liquid crystal display

2 Volume/Redial/Phonebook key



To adjust the volume.
To change Hiragana into Kanji.



To redial the phone numbers in the redial list. The last 10 phone numbers dialed are stored in memory.



To use the phonebook.

3 Flash button

(For call waiting service users.)

Clear/Erase button

4 Auto Answer button & indicator

—light on: answering device activated.
—light off: used as a regular telephone.

5 Replay button plays back recorded messages.

Record button records telephone calls.

6 Intercom button

Character Input Mode button

7 Hold button

Call Memory button starts a search in the Number Display log.

(For caller ID display service users.)

8 Tone button switches to tone dialing.

9 Set button

Resolution button selects the resolution when faxing or copying.

10 Function button initiates programming.

Edit button

11 Stop button

12 Copy button starts copying.

13 Fax button starts faxing.

Finding the controls

Portable handset (KX-FKN511)

Liquid crystal display

① Portable handset number
 ② Indicates which directions the key can be tilted.

変換
再ダイヤル 電話帳

▲ ▼ ◀ ▶

up and down left

③ No link to the base unit
 ④ Battery strength
 ⑤ Function menu that is controlled by **F1** or **F2**

● To change the tone heard from the earpiece.

● To adjust the volume.

Dial buttons

* トーン ● To switch to tone dialing.

Sharp button

● For call waiting service users.

ボイスチェンジ ● To change your voice.
 ● To mute your voice to the other party by pressing this button for about 2 seconds. (To release the mute, press this button again.)

スピーカーホン ● To use the speakerphone.

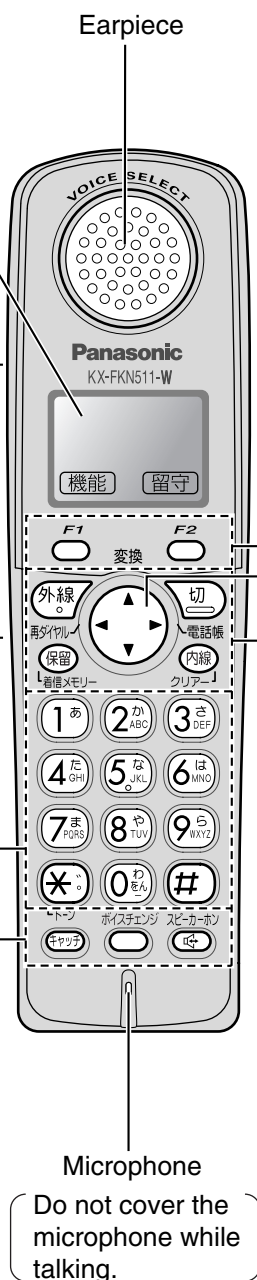

How to use **F1** **F2** buttons

F1 and **F2** buttons refer to the function displayed on the bottom of the display. They function differently depending on the mode.

How to use 変換 key

再ダイヤル 電話帳

● To use the phonebook.

再ダイヤル ● To redial the phone numbers in the redial list. The last 10 phone numbers dialed are stored in memory.

変換 ● To change Hiragana into Kanji.

● To make/answer calls.

● To end a call.
 ● To end or exit from editing or other operations.

● To page the main unit and/or portable handset(s).
 ● To clear letters/numbers.

● To put a call on hold.
 ● To start a search in the Number Display log. (For caller ID display service users.)

Installations and connections

Installing the ink film

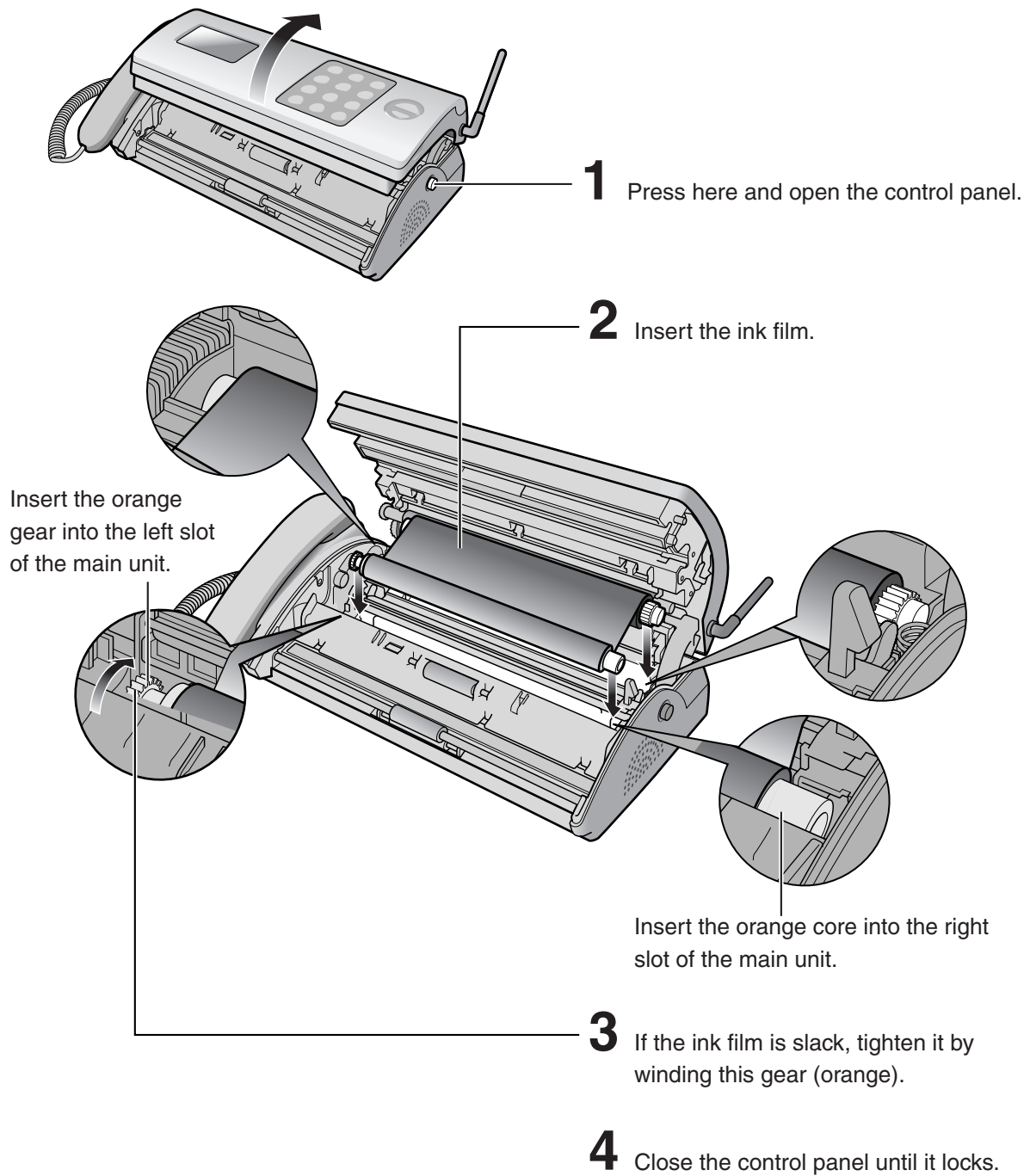

- When the unit runs out of ink film, the following message will be displayed.

フィルムがなくなりましたU23
交換してください



フィルムがなくなりましたU23
品番: KX-FAN200

Install a new ink film.

Replacement ink film:
KX-FAN200 (30 m) ¥1,208

・ As of February 2005. ・ Tax included.

Installations and connections

Installing recording paper (A4 size)

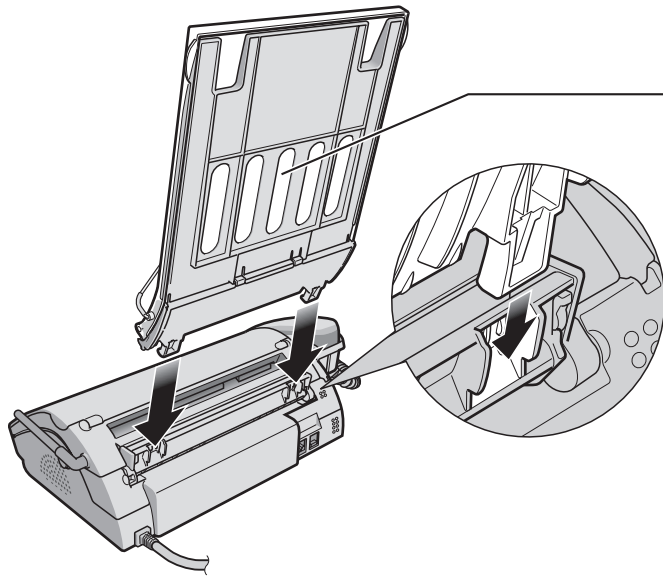

1 Install the recording paper cover/tray.

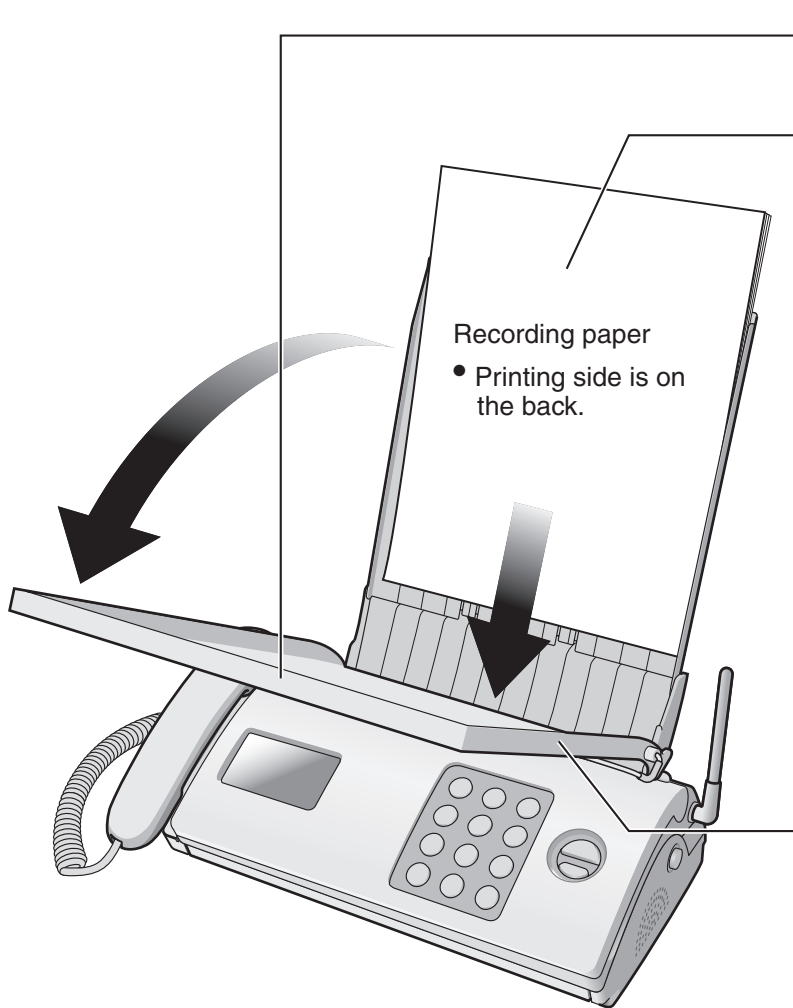

2 Open the recording paper cover.

3 Insert the recording paper into the recording paper tray. (Up to 20 sheets)

- Fan the stack of recording paper.

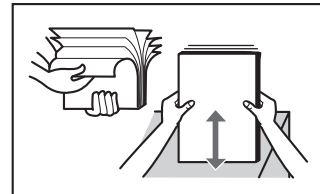

4 Close the recording paper cover.

Installations and connections

Connecting the main unit

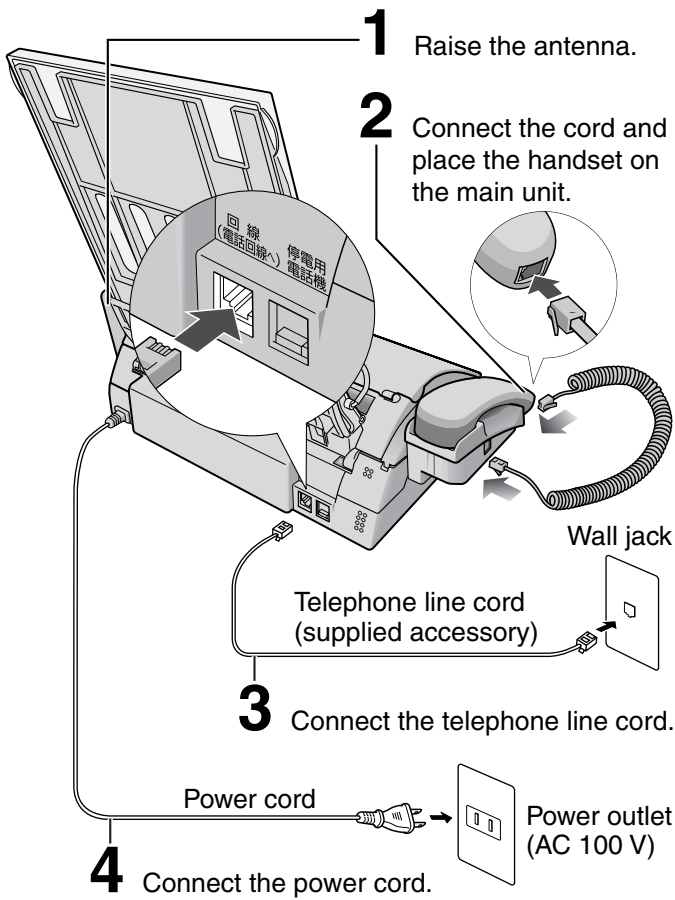

After the Power On...

This unit will automatically select the dialing mode (Tone/Pulse).



If you can not make a call...

Set the dialing mode with the main unit.

1. Press (Function/Edit).
2. Press .
3. Press (Search button) repeatedly until the desired setting is displayed.

Example :

回線種別=20	フツユ: Tone
[◀, 決定] 押す	20 : Pulse (20 pps)
	10 : Pulse (10 pps)

4. Press (Set/Resolution).

5. Press (Stop).

Setting up the portable handset (KX-FKN511)

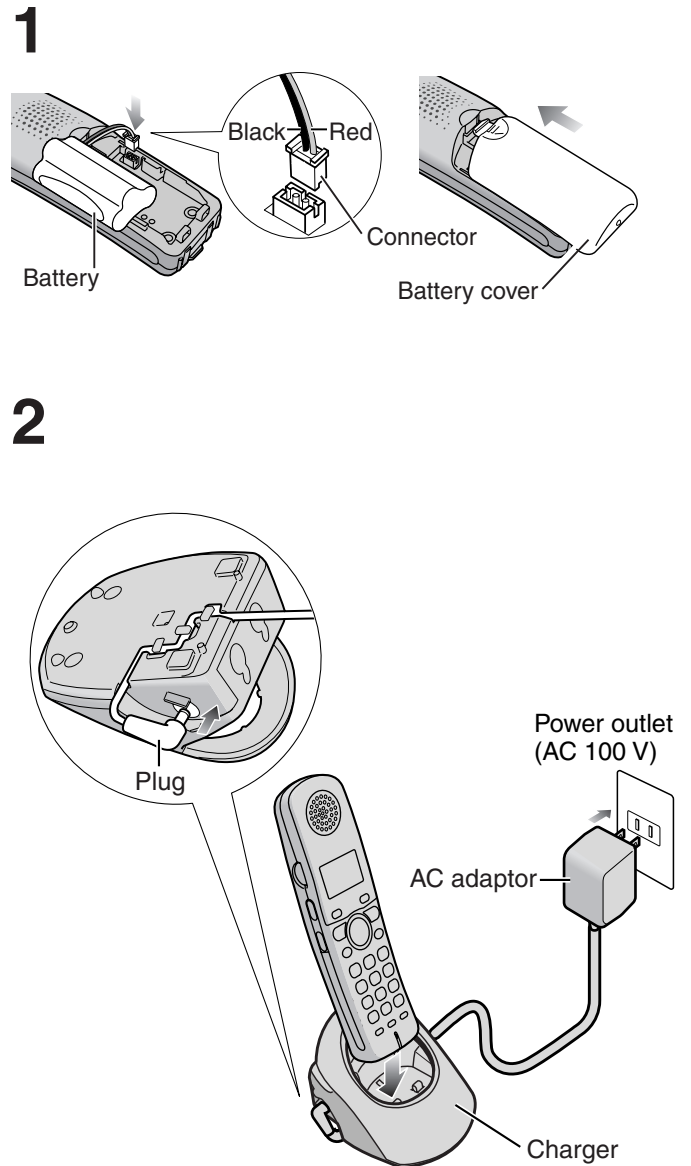

- 3** Charge the battery in the charger for 10 hours.

After your Panasonic battery is fully charged, it will last up to about 7 hours of conversation.

Setting the date and time

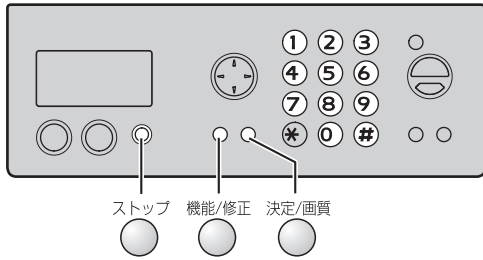

1 Press ^{機能/修正} (Function/Edit).
機能登録モード [▼▲]押す

2 Press # 0 0 1.
Example: 2005年06月01日
20:10
Cursor

3 Enter the correct year/month/day.
Example: October 1, 2005
Press 2 0 0 5 1 0 0 1.
2005年10月01日
20:10

4 Enter the correct hour/minute in a 24-hour clock entry.
Example: 15:45 (3:45 PM)
Press 1 5 4 5.
2005年10月01日
15:45

5 Press ^{決定/画質} (Set/Resolution).
登録しました
↓
2005年10月01日
15:45

6 Press ^{ストップ} (Stop).
Example: 10月 1日 15:45
用件録音 00件

Setting your facsimile telephone number

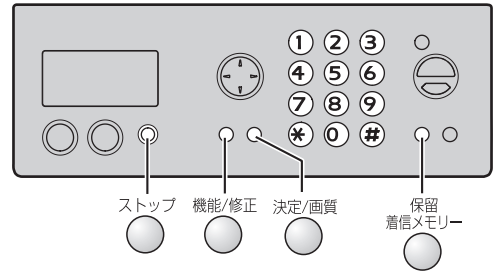

1 Press ^{機能/修正} (Function/Edit).
機能登録モード [▼▲]押す

2 Press # 0 0 4.
あなたの電話番号?
.....
Cursor

3 Enter your facsimile telephone number, up to 20 digits.
Example: 123 456 78..
あなたの電話番号?
123 456 78.....

^{保留着信メモリー}
The (Hold/Call memory) button replaces the digit with a space.

4 Press ^{決定/画質} (Set/Resolution).
登録しました
↓
あなたの電話番号?
123 456 78.....

5 Press ^{ストップ} (Stop).
Example: 10月 1日 15:45
用件録音 00件

Setting your logo

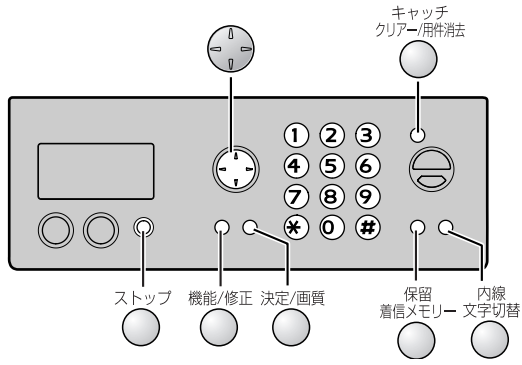

1 Press (Function/Edit).

機能登録モード
[▼▲]押す

2 Press .

名前 (印刷用)?
>_ [かな]
Cursor

3 Enter your logo, up to 30 characters, using the dial keypad.

- To enter English characters easily, press (Intercom/Character input mode) repeatedly and select “英” (English and sign input mode).
- For details, see the table on page 9 for instructions.

Example: Micah

1. Press once.

M [英]
Cursor

2. Press six times.

Mi [英]

3. Press six times.

Mic [英]

4. Press to move the cursor to the next space and press four times.

Mica [英]

5. Press five times.

Micah [英]

4 Press (Set/Resolution).

登録しました
↓
Micah
>_ [かな]

5 Press (Stop).

Example : 10月1日 15:45
用件録音 00件

Character input and command key table

Pressing the dial keys will select a character as shown below.

Character		“かな” Hiragana	“カナ” Katakana	“英” English	“数” Numbers
Dial key					
(Main unit) ①	(Portable handset KX-FKN511) ①	あいうえお あいうえお	アイウエオ アイウエオ	@ . _ - & \$ ¥ % + = ^ ^	1
②	②	かきくけこ	カキクケコ	A B C a b c	2
③	③	さしすせそ	サシスセソ	D E F d e f	3
④	④	たちつてとっ	タチツテトツ	G H I g h i	4
⑤	⑤	なにぬねの	ナニヌネノ	J K L j k l	5
⑥	⑥	はひふへほ	ハヒフヘホ	M N O m n o	6
⑦	⑦	まみむめも	マミムメモ	P Q R S p q r s	7
⑧	⑧	やゆよやゆよ	ヤユヨヤユヨ	T U V t u v	8
⑨	⑨	らりるれろ	ラリルレロ	W X Y Z w x y z	9
⑩	⑩	わをんー! ? ()	ワヲンー! ? ()	! ? / - * # , ; : . ' " () [] { } < > 「 」	0
* (Main unit)	* (Portable handset)	” ” ” ”	” ” ” ”	” ” ” ”	
Command keys		内線 文字切替 ○ (Main unit), F2 (Portable handset)		Used to change the character input mode.	
		○ (Main unit), ○ (Portable handset)		Used to move the cursor to the left and right.	
		キャッチ クリアー/用件消去 ○ (Main unit), 内線 クリアー (Portable handset)		Used to delete a character.	
		保留 着信メモリー ○ (Main unit), 保留 着信メモリー (Portable handset)		Used to insert a space.	

• The characters on the display are somewhat different from those shown in the character input and command key table.

Automatic dialing on the main unit

Storing names and telephone numbers in the phonebook

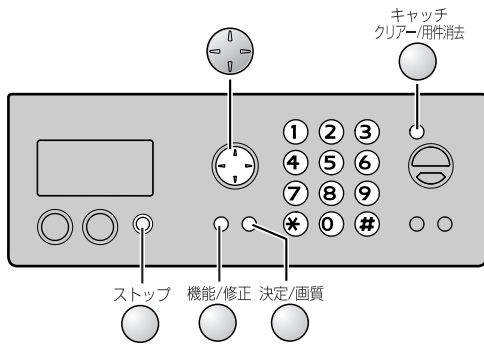

1 Press 電話帳 (Phonebook).

登録は[決定]を押す
検索は[▼▲]を押す

2 Press (Set/Resolution).

- “XXX” shows the remaining station numbers you can store.
- You can program up to 150 stations, including 4 pre-programmed stations.

電話帳空き XXX件

3 Enter the name, up to 20 characters (see the table on page 9 for instructions).

4 Press (Set/Resolution) twice.

5 Enter the telephone number, up to 24 digits.

- To correct a mistake, press (Flash/Clear/Erase).

6 Press (Set/Resolution).

7 Enter the group number (① to ⑨).

8 Press (Set/Resolution).

- To program other items, repeat steps 3 to 8.

9 Press (Stop) to exit the program.

Making a voice call using the phonebook

1 Press 電話帳 (Phonebook).

2 Press (Search button) repeatedly until the desired name is displayed.

3 Lift the handset.

Editing a stored name or number in the phonebook

1 Press 電話帳 (Phonebook).

2 Press (Search button) repeatedly until the desired name is displayed.

3 Press (Function/Edit).

4 Edit the name (see the table on page 9 for instructions).

- If you do not need to edit the name, skip to step 5.

5 Press (Set/Resolution).

6 Edit the kana.

- If you do not need to edit the kana, skip to step 7.

7 Press (Set/Resolution).

8 Edit the telephone number.

- If you do not need to edit the telephone number, skip to step 9.

9 Press (Set/Resolution).

10 Edit the group number.

- If you do not need to edit the group number, skip to step 11.

11 Press (Set/Resolution).

12 Press (Stop).

Automatic dialing on the portable handset (KX-FKN511)

Storing names and telephone numbers in the phonebook

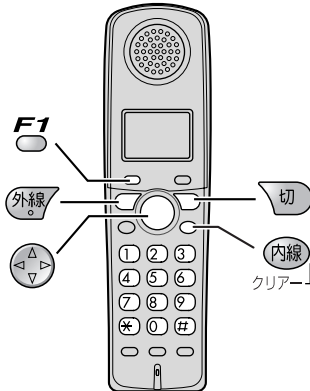

- 1 Press (Phonebook).

検索は [▼▲]を押す

- 2 Press .
 - “XXX” shows the remaining station numbers you can store.
 - You can program up to 150 stations, including 4 pre-programmed stations.

名前?
空き XXX 件
- 3 Enter the name, up to 20 characters (see the table on page 9 for instructions).
- 4 Press twice.
- 5 Enter the telephone number, up to 24 digits.
 - To correct a mistake, press (Clear).
- 6 Press .
- 7 Enter the group number (① to ⑨).
- 8 Press .
- To program other items, repeat steps 3 to 8.
- 9 Press (Off) to exit the program.

Making a voice call using the phonebook

- 1 Press (Phonebook).
- 2 Press (Search button) repeatedly until the desired name is displayed.
- 3 Press (Talk).

Editing a stored name or number in the phonebook

- 1 Press (Phonebook).
- 2 Press (Search button) repeatedly until the desired name is displayed.
- 3 Press .
- 4 Edit the name (see the table on page 9 for instructions).
 - If you do not need to edit the name, skip to step 5.
- 5 Press .
- 6 Edit the kana.
 - If you do not need to edit the kana, skip to step 7.
- 7 Press .
- 8 Enter the correct telephone number.
 - If you do not need to edit the telephone number, skip to step 9.
- 9 Press .
- 10 Edit the group number.
 - If you do not need to edit the group number, skip to step 11.
- 11 Press .
- 12 Press (Off) to exit the program.

Intercom

An intercom is available between the portable handsets or between the main unit and portable handset(s).

Using the main unit:

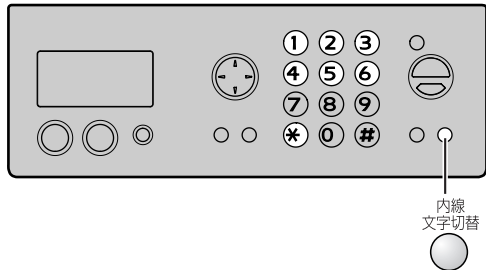

1 ■ For single portable handset users

- ① Lift the handset.

内線
文字切替

- ② Press  (Intercom/Character input mode).

番号?

子機 1 呼出中

■ For multiple portable handset users

- ① Lift the handset.

内線
文字切替

- ② Press  (Intercom/Character input mode).

- ③ Call the portable handset(s) in the following ways:

- To call a specific portable handset, press the portable handset number (① to ⑥) which you want to call.
- To call all the portable handsets, press .

2 Start talking.

Example : 子機 1 内線通話中

3 Replace the handset to end the intercom call.

Using the portable handset (KX-FKN511):

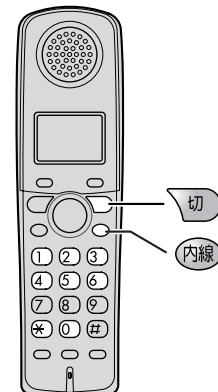



1 ■ For single portable handset users

Press  (Intercom).

■ For multiple portable handset users

- ① Press  (Intercom).

- ② Call the main unit and/or portable handset(s) in the following ways:

- To call a specific portable handset, press the portable handset number (① to ⑥) which you want to call.
- To call the main unit, press .
- To call the main unit and all the portable handsets, press .

2 Start talking.

内線通話中 

3 Press (Off) to end the intercom call.

Sending faxes

Sending a fax manually

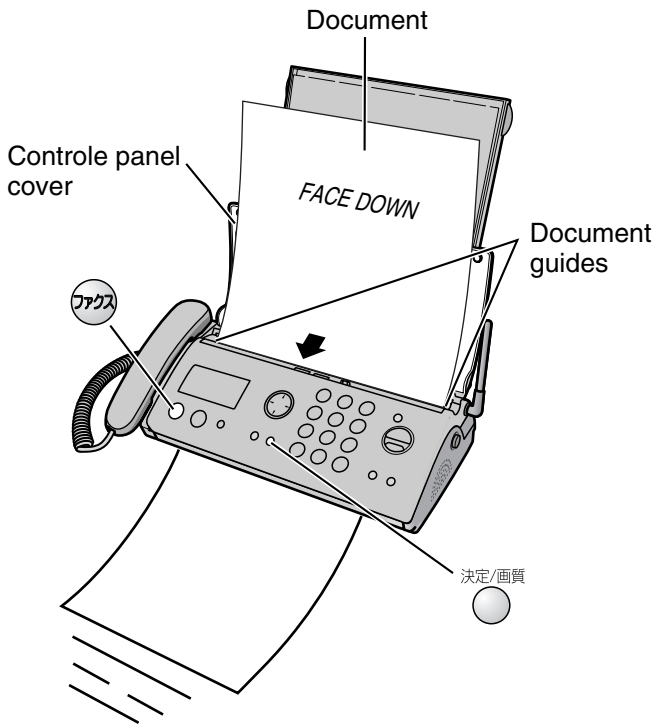

- 1 Open the control panel cover, and adjust the width of the document guides to the size of the document.
- 2 Insert the document (up to 5 pages) FACE DOWN until a single beep is heard.
- 3 If necessary, press 決定/画質 (Set/Resolution) repeatedly to select the desired setting (see below).
- 4 Dial the fax number.
- 5 Press **ファクス** (Fax).
 - The unit will start fax transmission.

Sending a fax using automatic dialing

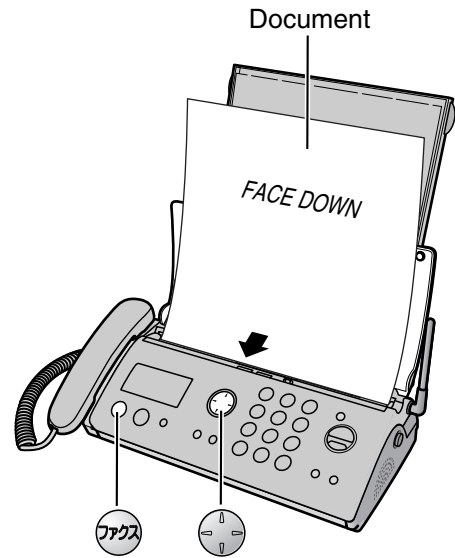

Using the phonebook

- 1 Insert the document (up to 5 pages) FACE DOWN until a single beep is heard.
- 2 Press **電話帳** (Phonebook).
- 3 Press **検索** (Search button) repeatedly until the desired name is displayed.
- 4 Press **ファクス** (Fax).
 - The unit will start fax transmission.

To select the resolution

Select the desired resolution according to the type of document, by pressing 決定/画質 (Set/Resolution).

画質=通常	(Standard) for printed or typewritten originals with normal-sized characters.
画質=小さい	(Fine) for originals with minute printing.
画質=写真	(Photo) for originals containing photographs.

Receiving faxes

Receiving a fax manually (AUTO ANSWER off)

Using the main unit:

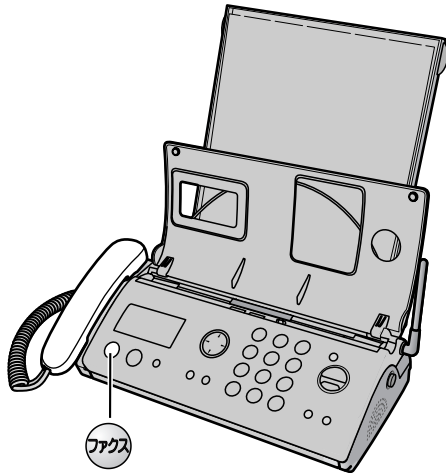

1 When you hear a ring, lift the handset to answer the call.

2 When:
– document reception is required,
– a fax calling tone (slow beep) is heard, or
– no sound is heard,

press  (Fax), then replace the handset.

- The unit will start fax reception.

Using the portable handset (KX-FKN511):

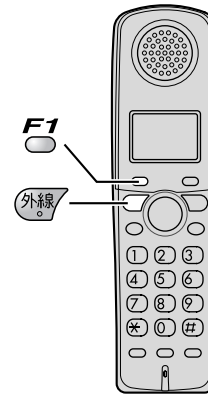

1 When you hear a ring, lift the portable handset from the charger to answer the call.

- If the portable handset is not set on the charger, press  (Talk).

2 When:
– document reception is required,
– a fax calling tone (slow beep) is heard, or
– no sound is heard,

press  until a single beep is heard.

- The main unit will start fax reception.

Receiving faxes

Receiving a fax automatically (AUTO ANSWER on)

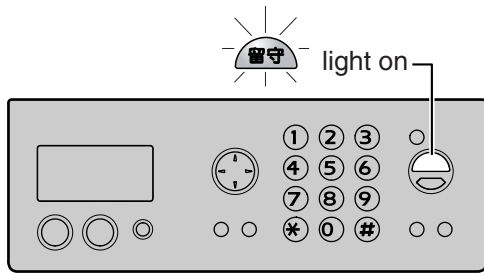

- 1 If the **留守** (Auto answer) light is off, turn it on by pressing **留守**.
- 2 When receiving a call, the unit will receive a fax document or record a voice message automatically depending on the caller's request.

Operating the built-in answering device

Recording your own greeting message

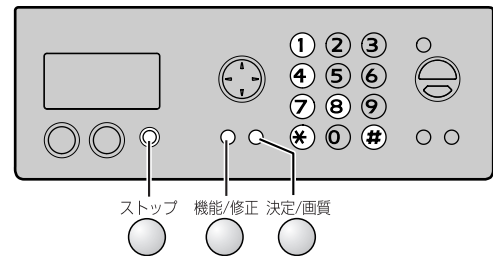

You can record your own greeting message. When receiving a call, it will be played to callers instead of the pre-recorded Japanese greeting message.

- 1 Press **機能/修正** (Function/Edit).
- 2 Press **# 1 4 7**.

自作応答録音
[決定]押す
- 3 Press **決定/画質** (Set/Resolution).
- 4 Lift the handset.
- 5 Press **決定/画質** (Set/Resolution) and speak your greeting message after a beep, up to 16 seconds, to the handset.
- 6 Press **ストップ** (Stop) and replace the handset.
 - Your greeting message will be played back automatically.

Erasing your own greeting message

- 1 Press **機能/修正** (Function/Edit).
- 2 Press **# 1 4 8**.

自作応答消去
[決定]押す
- 3 Press **決定/画質** (Set/Resolution).
- 4 Press *****.
 - The pre-recorded Japanese greeting message will be played when you receive a call.

Operating the built-in answering device

Activating the answering device

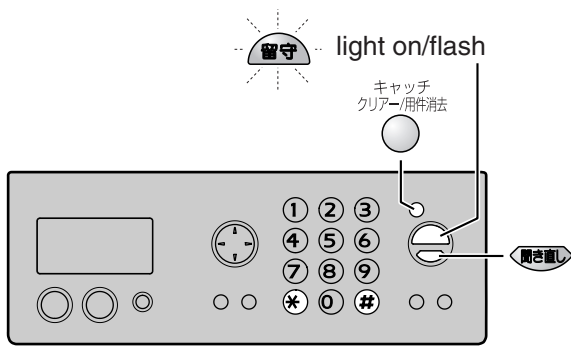

- 1 Turn the **留守** (Auto answer) light on by pressing **留守**.
- 2 When receiving a call, a greeting message will be played and the unit will record a voice message.
 - To record your own greeting message, see page 15.

Listening to recorded messages

When new messages are recorded, the **留守** (Auto answer) light will flash.

Press **留守** to listen to recorded messages.
After the messages are played back, the following will be displayed.

- To erase the messages, press *****.

再生した用件を消去 する=* しない=#

- To save the messages, press **#**.

Listening to all of the recorded messages

Press **聞き直し** (Replay).

After the messages are played back, the following will be displayed.

- To erase the messages, press *****.

再生した用件を消去 する=* しない=#

- To save the messages, press **#**.

Erasing a specific message

Press **キャッチ クリアー/用件消去** (Flash/Clear/Erase) while listening to the message you want to erase, then press *****.

Erasing all of the recorded messages

1 Press **キャッチ クリアー/用件消去** (Flash/Clear/Erase).

2 Press *****.

すべて消去しますか? はい=* いいえ=#

Operating the built-in answering device

Operating the answering device from a remote location

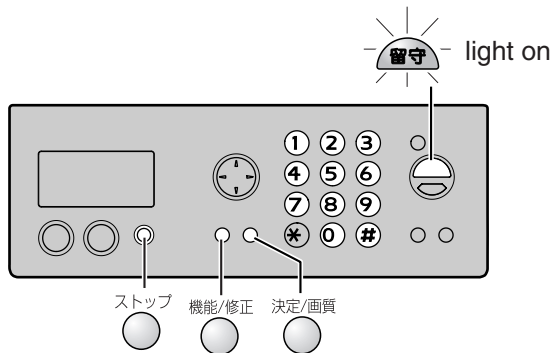

Preparation: Programming the remote operation ID

1. Press (Function/Edit).
2. Press .
3. Enter any 4-digit number (remote operation ID) except * or #.

Example :

暗証番号=1234
[4桁, 決定] 押す

4. Press (Set/Resolution).
5. Press (Stop).

Operation: Listening to a recorded message from a remote location

Turn the (Auto answer) light on before you go out. Remote operations are available only from a touch tone telephone.

1. Call your unit.
2. Enter the remote operation ID during the greeting message.
3. Press or wait 4 seconds.
 - Only the new recorded messages will be played back.
 - To listen to all the recorded messages, press after the new messages have been played back.

Specifications

KX-PW603DL KX-PW603DW	Main unit	Portable handset (KX-FKN511)	Battery charger
Power supply	AC 100 V (50 Hz/60 Hz)	Ni-MH battery (Part no. KX-FAN50) DC 3.6 V, 600 mAh	AC adaptor (Part no. PFAP1009) AC 100 V (50 Hz/60 Hz) DC 7.5 V, 100 mA
Power consumption	Transmission: Approx. 10 W Reception: Approx. 15 W Copy: Approx. 20 W Stand by: Approx. 0.9 W (When the F-net service is not in use.) Maximum(*1): Approx. 130 W		<ul style="list-style-type: none"> • Charging: Approx. 1.5 W • Stand by: Approx. 0.6 W
Dimensions (H x W x D)	Approx. 103 X 332.5 X 195 mm (without handset, projections) Approx. 355.5 X 332.5 X 233 mm (recording paper cover/tray installed, without handset, projections)	Approx. 171 X 48 X 38 mm	Approx. 65 X 86 X 96 mm
Mass (Weight)	Approx. 3.0 kg (10 m ink film installed)	Approx. 160 g (battery installed)	Approx. 75 g
Operating environment	5 °C – 35 °C, 45 % – 85 % RH (Relative Humidity)		

KX-PW603DL KX-PW603DW	Main unit
Applicable line	Public Switch Telephone Network (Tone/Pulse), F-Net, NCC Lines
DC resistance	320 Ω (*2)
Compatibility	G3 compatible
Document size	B4–A5 (Max. 257 mm in width, Max. 600 mm in length)
Effective scanning size	252 mm (B4), 208 mm (A4)
Effective printing size	202 mm (A4 size plain paper)
Transmission time	Approx. 15 s/page (Original mode) (*3)
Modem speed	9,600 / 7,200 / 4,800 / 2,400 bps; Automatic fallback
Halftone level	64-level
Scanning density	Horizontal: 8 pels/mm Vertical : 7.7 lines/mm (Fine/Photo), 3.85 lines/mm (Standard)
Scanner type	Contact image sensor
Printer type	Thermal transfer printing on plain paper
Data compression system	Modified Huffman (MH), Original mode
Recording paper size	A4: 210 mm x 297 mm (Plain paper)
Answering device	Greeting message: Digital recording system (up to 16 sec) Pre-recording greeting message ICM Recording: Digital recording system (Approx. 18 min. in total) (*4)
Memory capacity	Max. Approx. 46 pages (Only receiving fax etc.) (*5) Max. Approx. 18 min. (Only Recording message) (*4)

*1 When copying a 100% black document.

*2 If you cannot make a call due to DC resistance, consult your dealer.

*3 Transmission speed is based on an A4-size document of 700 characters sent in standard resolution at 9,600 bps. The actual transmission speed depends upon the contents of the page, resolution, telephone line conditions and capability of the other party's machine.

*4 If there is a silent pause, the total recording time will be longer.

*5 The memory capacity is based on an A4-size document of 700 characters.

